

Initial Sound "Tic Tac Toe" Games

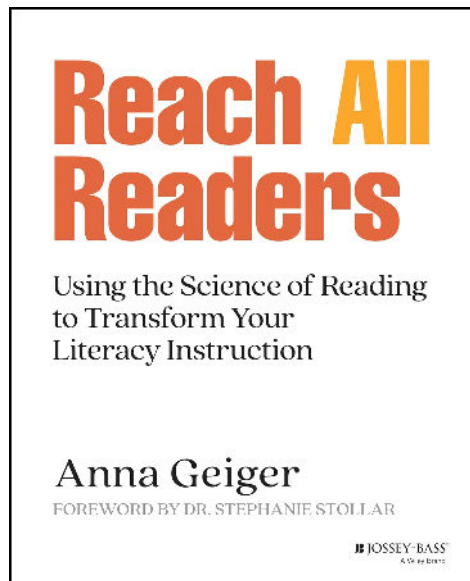

Read about this game on page 70 of *Reach All Readers*.

To get instant access to thousands of resources for teaching literacy and math, [check out our affordable membership!](#)

Terms of Use

This printable resource is the intellectual property of Anna Geiger, CEO of The Measured Mom, author of *Reach All Readers*, and creator of the accompanying online course (coming in September 2024).

You have permission to use this file for personal or classroom use only. In other words, you may print, copy, and use this file *only* with the students you teach.

You do not have permission to share between teachers/classrooms, alter this file, sell, host, email, give away, or share on a blog, in Facebook groups or forums, Google Drive, etc.

Thank you for abiding by the terms of use. Questions may be sent to hello@themeasuredmom.com.

Clip Art: Dazzling Clips

How to Use

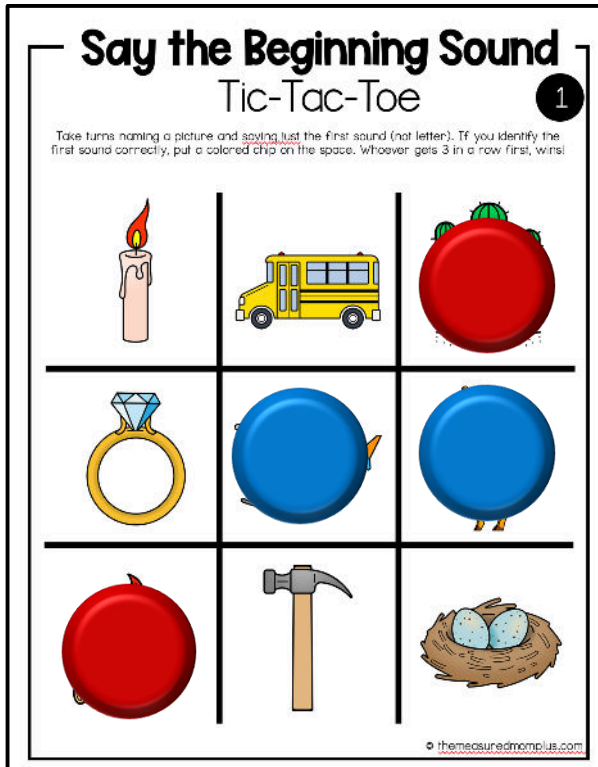

This printable is for students who need to develop the pre-reading skill of phonemic awareness.

Use it to help students learn to identify initial sounds, *not* initial letters.

Two players take turns naming a picture, saying its initial sound, and covering it with a colored chip. Whoever gets 3 in a row first, wins.

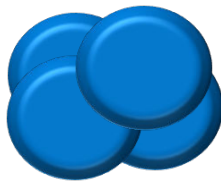
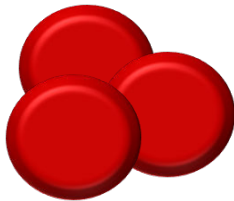

Picture Key

#1: candle, bus, cactus, ring, helicopter, giraffe, fire, hammer, nest

#2: socks, bee, saw, turtle, monkey, jam, jellyfish, pumpkin, yogurt

#3: cat, pig, lamp, banana, fox, castle, ant, leaf, map

#4: gum, octopus, rainbow, hat, worm, fish, tiger, sandwich, ladybug

#5: ball, yarn, net, house, kite, ham, robot, zipper, watermelon

#6: goat, ambulance, feather, king, cookie, egg, donut, zebra, watch

#7: book, vacuum, cake, turkey, igloo, elephant, die, volcano, wagon

#8: mushroom, baby, seal, violin, tent, lion, hand, fork, butterfly

Say the Beginning Sound

Tic-Tac-Toe

1

Take turns naming a picture and saying just the first sound (not letter). If you identify the first sound correctly, put a colored chip on the space. Whoever gets 3 in a row first, wins!

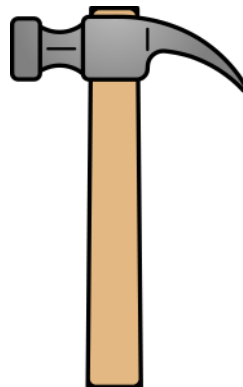
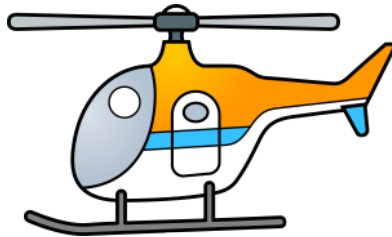
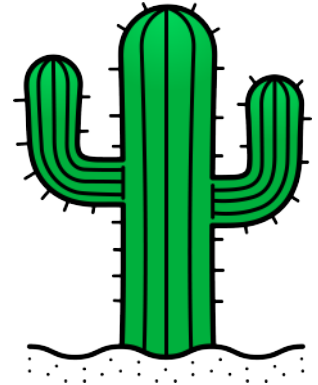

Say the Beginning Sound

Tic-Tac-Toe

2

Take turns naming a picture and saying just the first sound (not letter). If you identify the first sound correctly, put a colored chip on the space. Whoever gets 3 in a row first, wins!

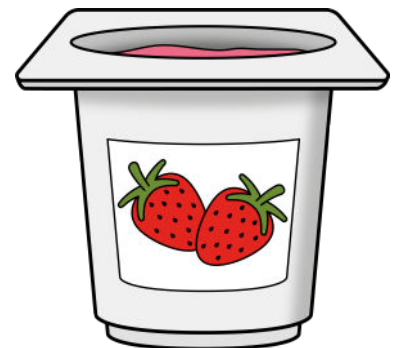
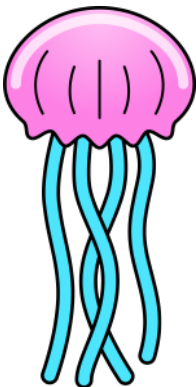
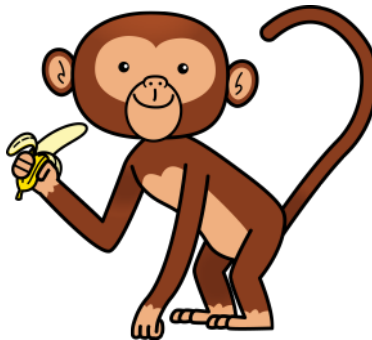
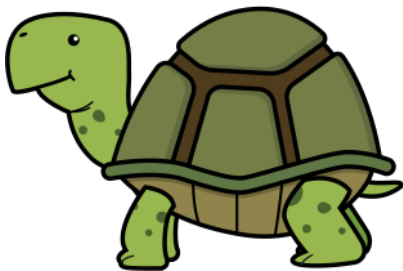
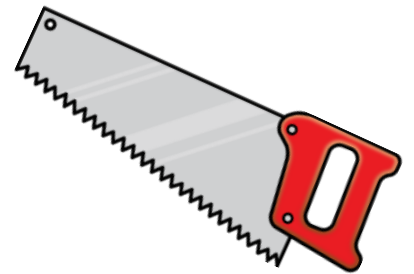

Say the Beginning Sound

Tic-Tac-Toe

3

Take turns naming a picture and saying just the first sound (not letter). If you identify the first sound correctly, put a colored chip on the space. Whoever gets 3 in a row first, wins!

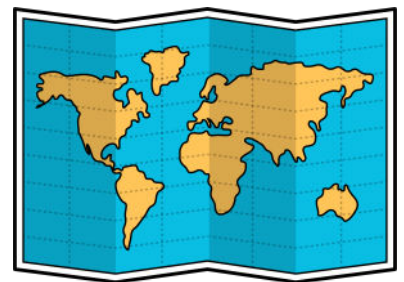
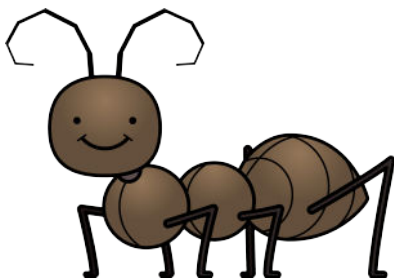
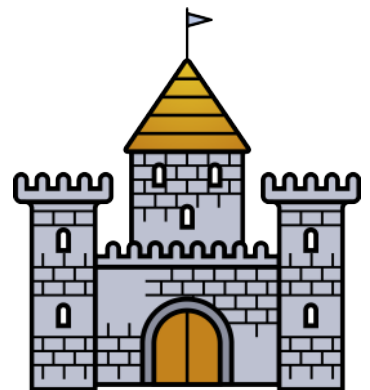
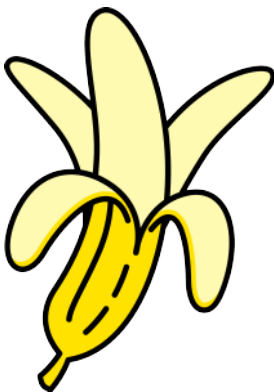
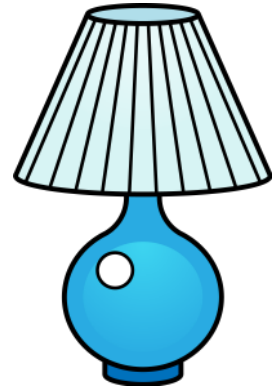
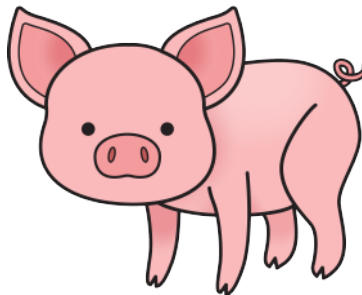
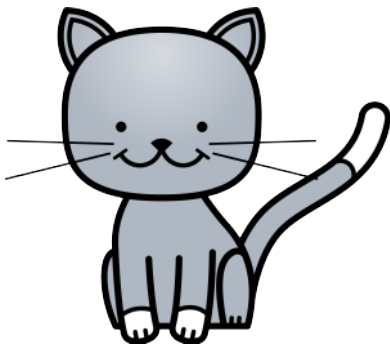

Say the Beginning Sound

Tic-Tac-Toe

4

Take turns naming a picture and saying just the first sound (not letter). If you identify the first sound correctly, put a colored chip on the space. Whoever gets 3 in a row first, wins!

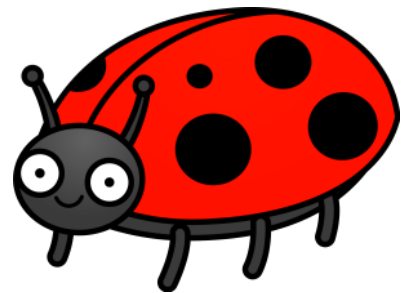
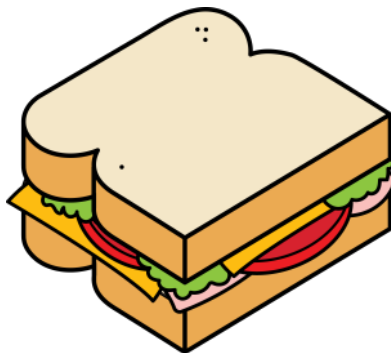
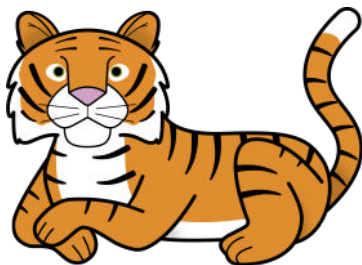
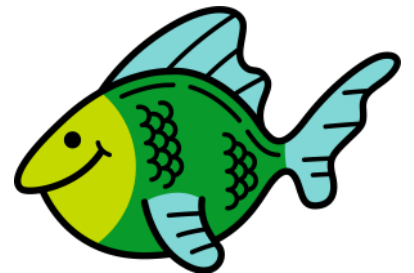
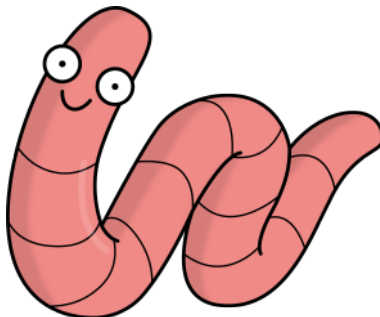
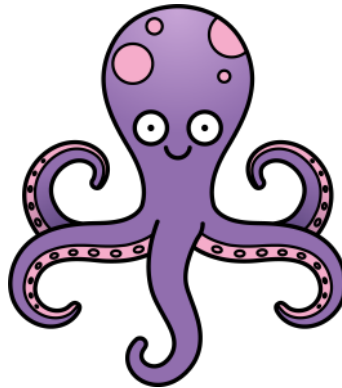
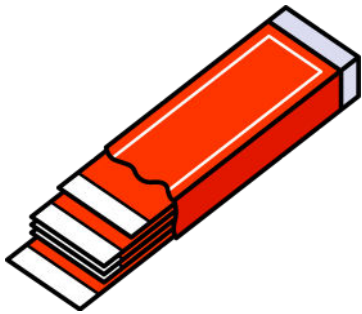

Say the Beginning Sound

Tic-Tac-Toe

5

Take turns naming a picture and saying just the first sound (not letter). If you identify the first sound correctly, put a colored chip on the space. Whoever gets 3 in a row first, wins!

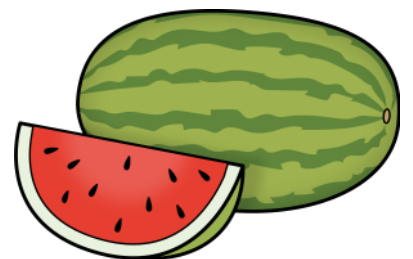
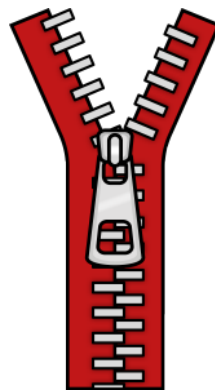
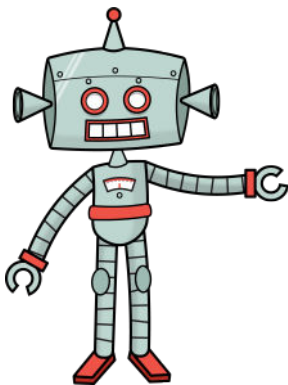
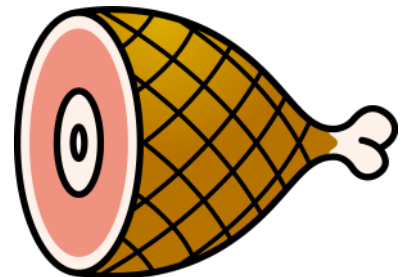
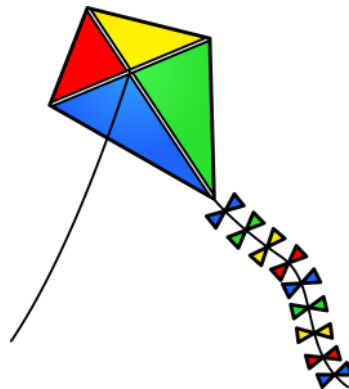
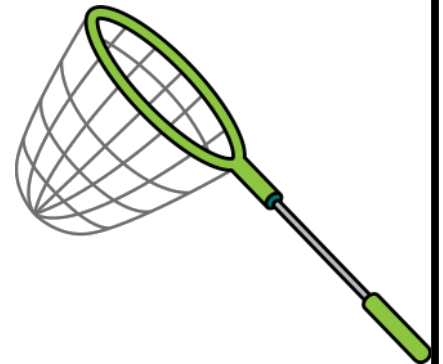

Say the Beginning Sound

Tic-Tac-Toe

6

Take turns naming a picture and saying just the first sound (not letter). If you identify the first sound correctly, put a colored chip on the space. Whoever gets 3 in a row first, wins!

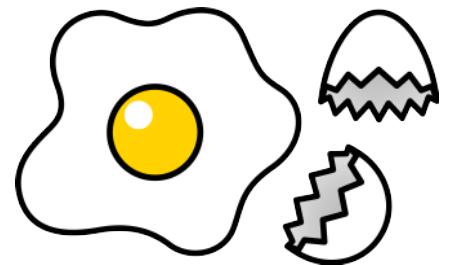
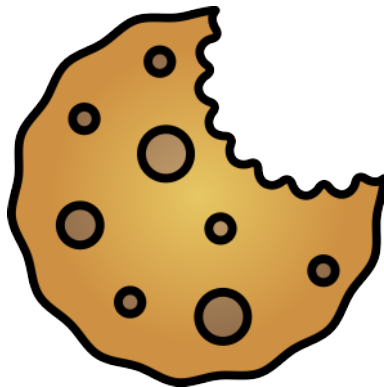

Say the Beginning Sound

Tic-Tac-Toe

7

Take turns naming a picture and saying just the first sound (not letter). If you identify the first sound correctly, put a colored chip on the space. Whoever gets 3 in a row first, wins!

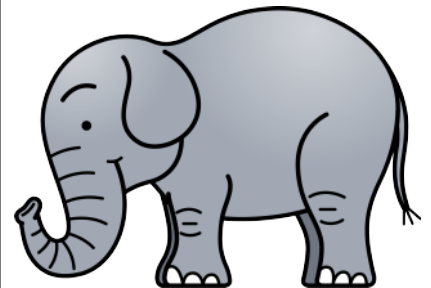
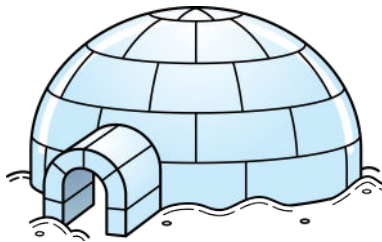
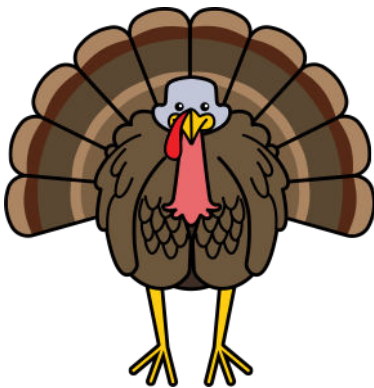
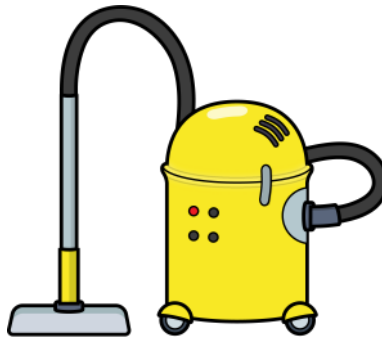

Say the Beginning Sound

Tic-Tac-Toe

8

Take turns naming a picture and saying just the first sound (not letter). If you identify the first sound correctly, put a colored chip on the space. Whoever gets 3 in a row first, wins!

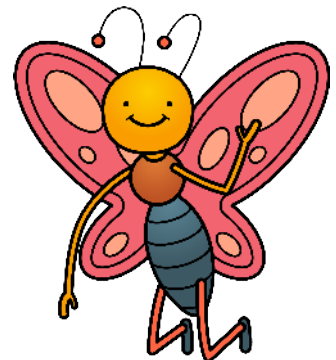
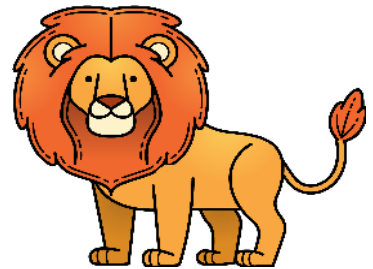
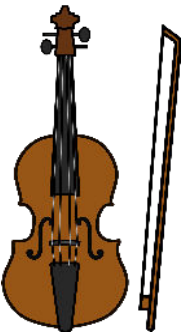

Say the Beginning Sound

Tic-Tac-Toe

1

Take turns naming a picture and saying just the first sound (not letter). If you identify the first sound correctly, put a colored chip on the space. Whoever gets 3 in a row first, wins!

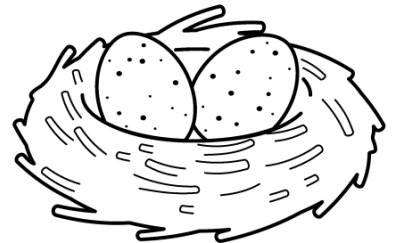
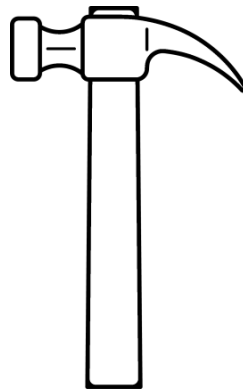
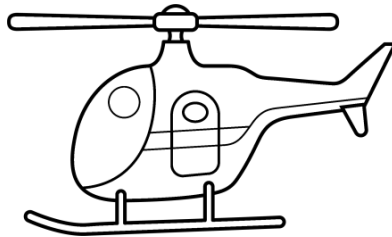
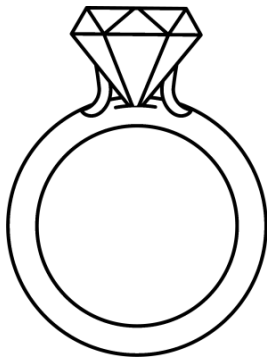
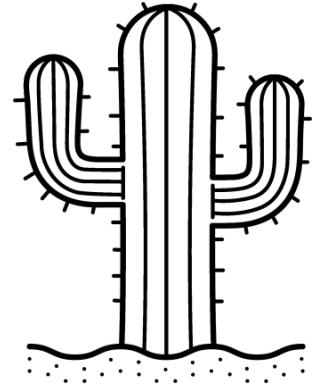
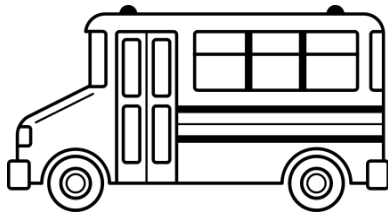

Say the Beginning Sound

Tic-Tac-Toe

2

Take turns naming a picture and saying just the first sound (not letter). If you identify the first sound correctly, put a colored chip on the space. Whoever gets 3 in a row first, wins!

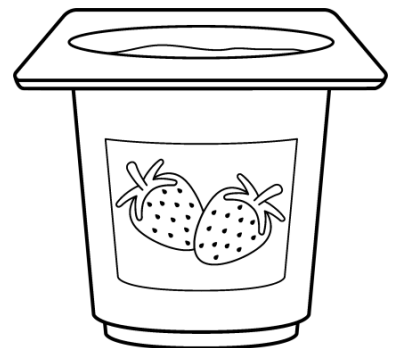
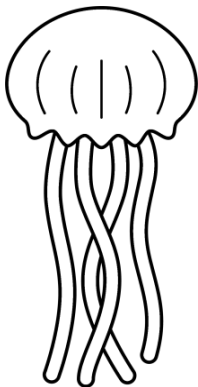
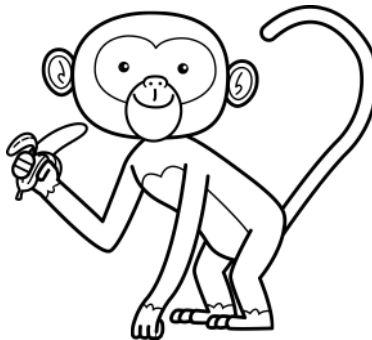
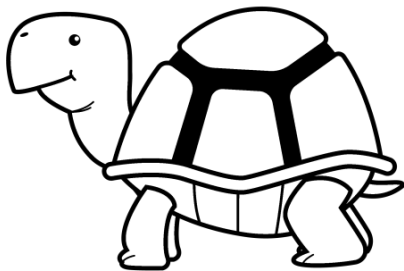
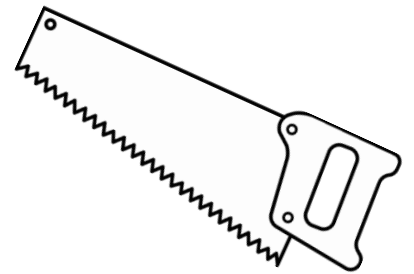
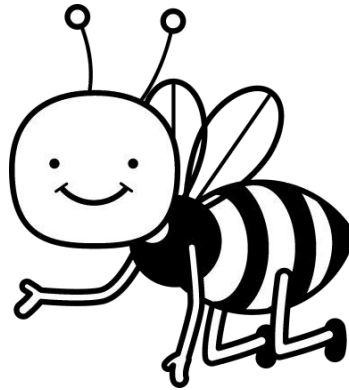

Say the Beginning Sound

Tic-Tac-Toe

3

Take turns naming a picture and saying just the first sound (not letter). If you identify the first sound correctly, put a colored chip on the space. Whoever gets 3 in a row first, wins!

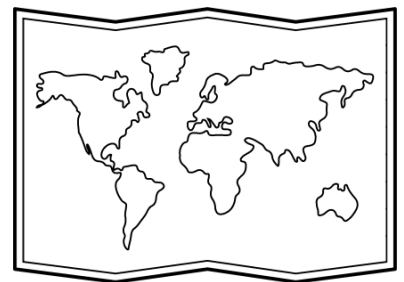
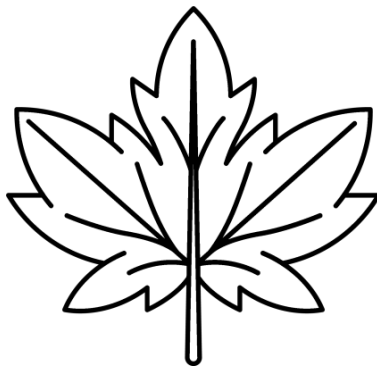
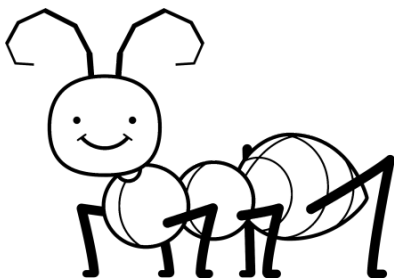
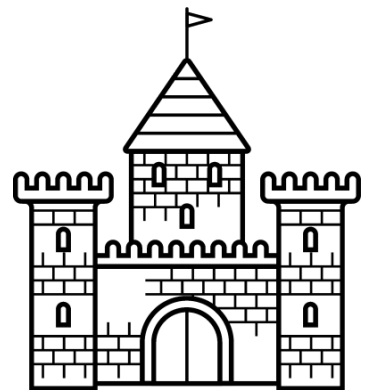
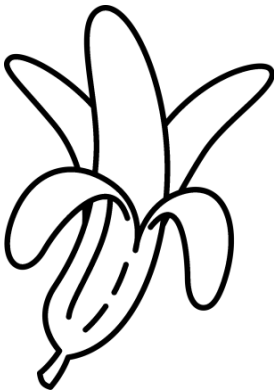
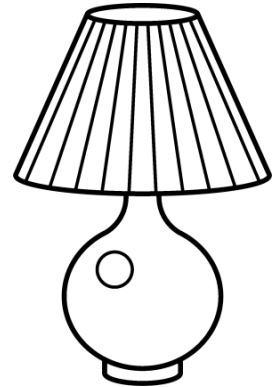
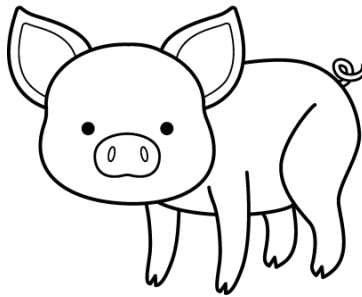
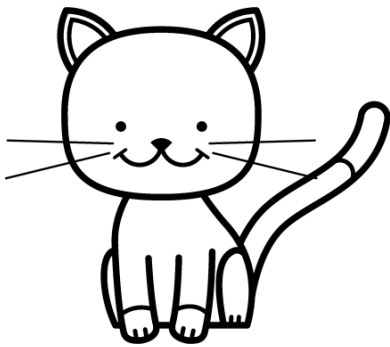

Say the Beginning Sound

Tic-Tac-Toe

4

Take turns naming a picture and saying just the first sound (not letter). If you identify the first sound correctly, put a colored chip on the space. Whoever gets 3 in a row first, wins!

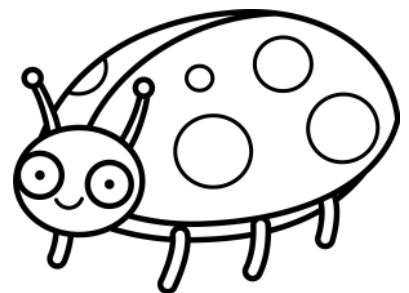
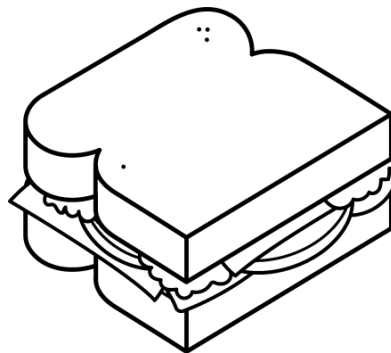
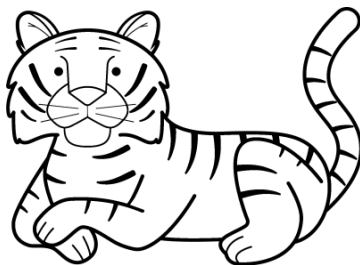
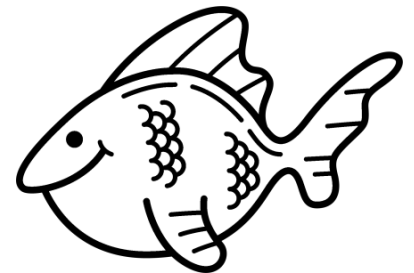
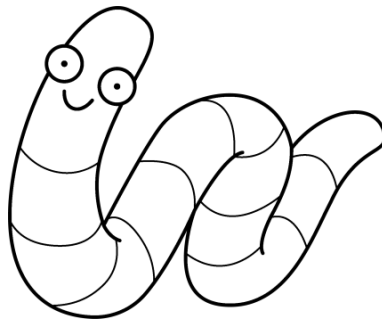
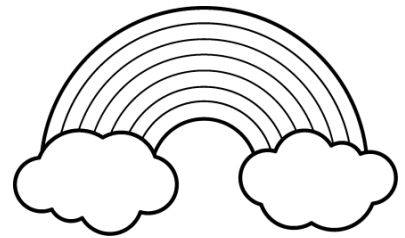
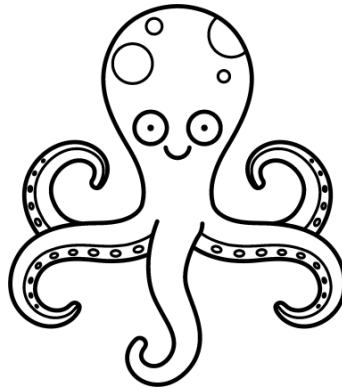
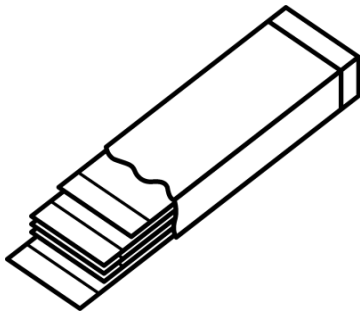

Say the Beginning Sound

Tic-Tac-Toe

5

Take turns naming a picture and saying just the first sound (not letter). If you identify the first sound correctly, put a colored chip on the space. Whoever gets 3 in a row first, wins!

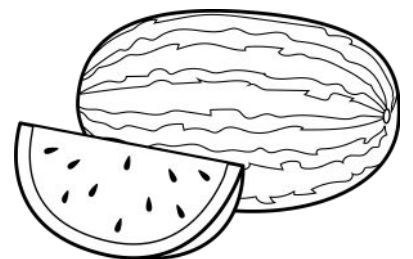
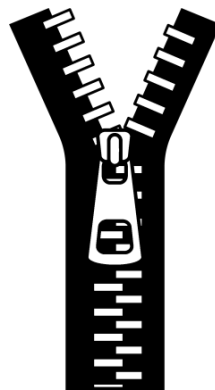
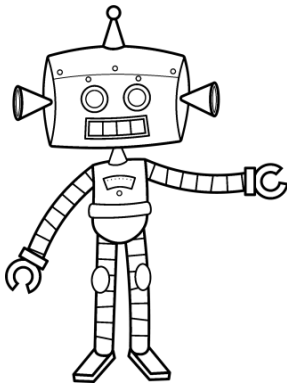
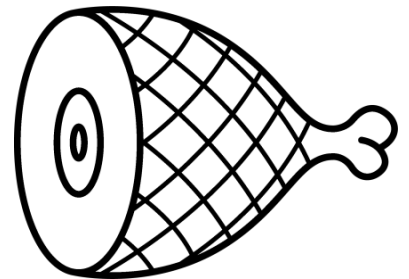
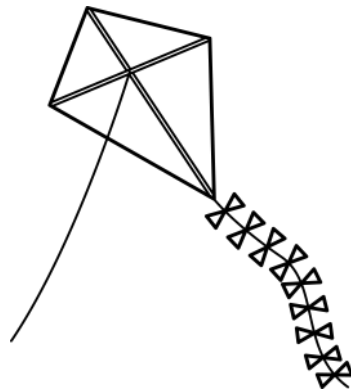
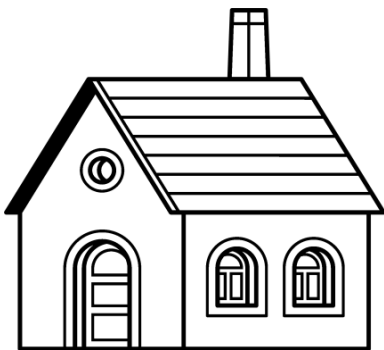
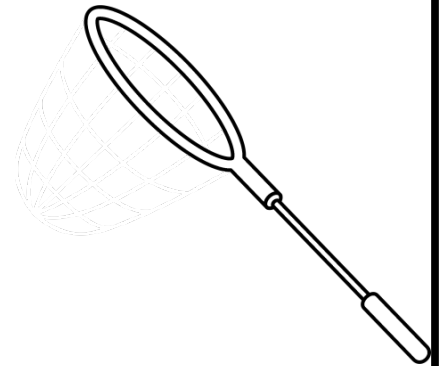
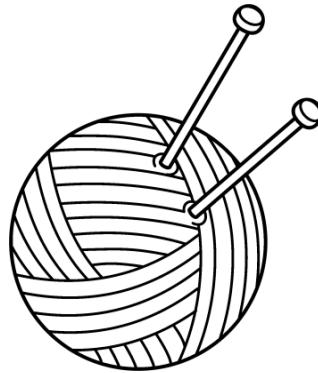
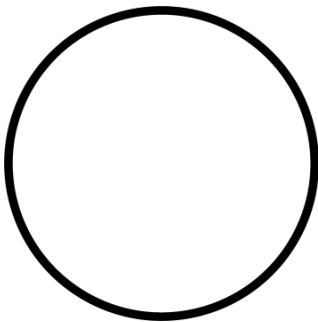

Say the Beginning Sound

Tic-Tac-Toe

6

Take turns naming a picture and saying just the first sound (not letter). If you identify the first sound correctly, put a colored chip on the space. Whoever gets 3 in a row first, wins!

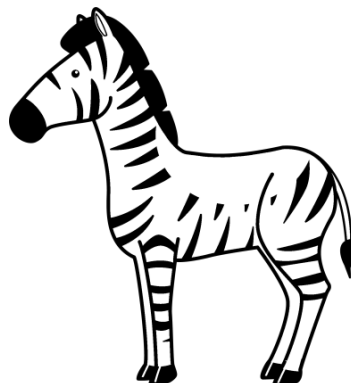
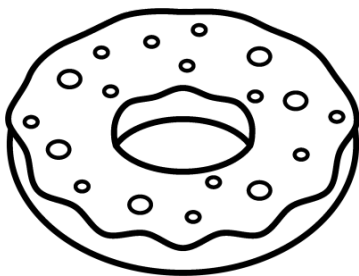
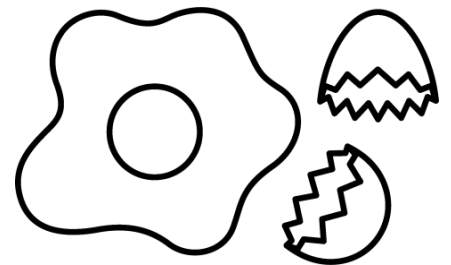
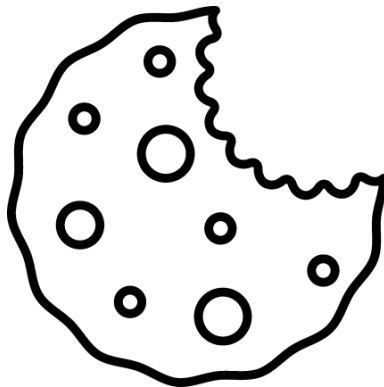
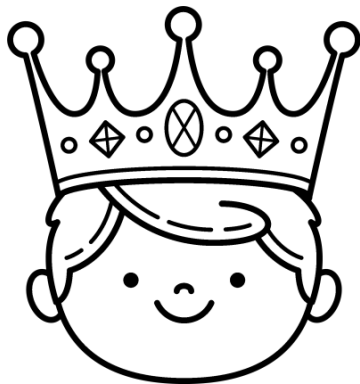
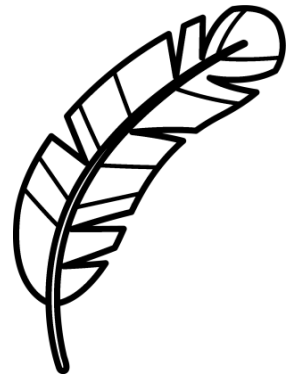
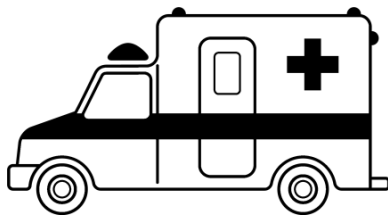
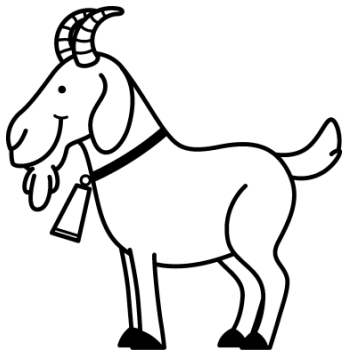

Say the Beginning Sound

Tic-Tac-Toe

7

Take turns naming a picture and saying just the first sound (not letter). If you identify the first sound correctly, put a colored chip on the space. Whoever gets 3 in a row first, wins!

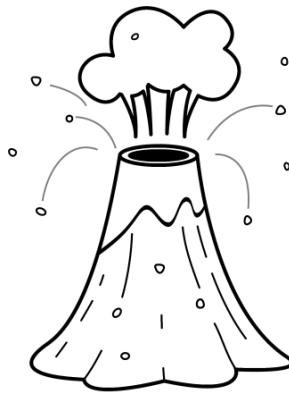
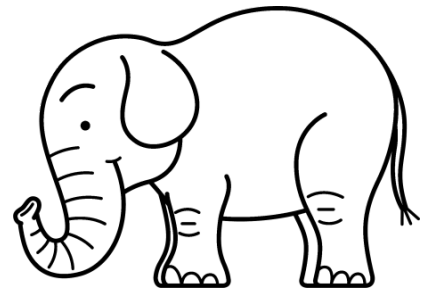
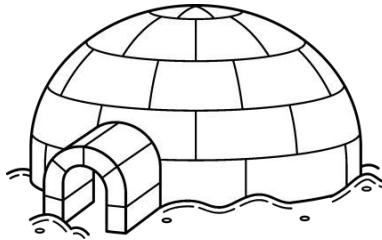
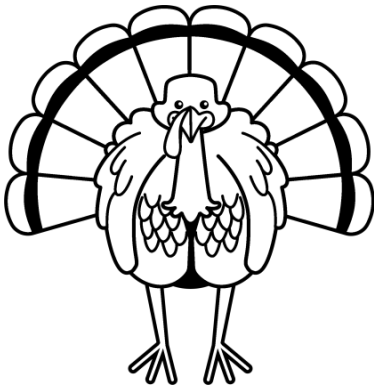
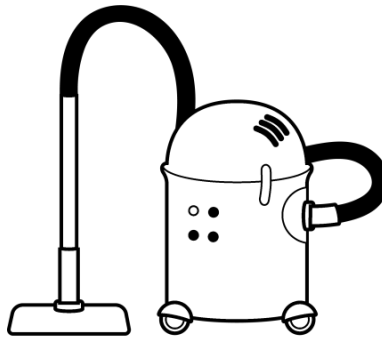
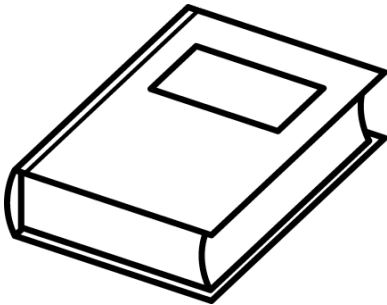

Say the Beginning Sound

Tic-Tac-Toe

8

Take turns naming a picture and saying just the first sound (not letter). If you identify the first sound correctly, put a colored chip on the space. Whoever gets 3 in a row first, wins!

